

ZS-6204E
USB-DIO Unit

User's manual



Zip Code: 183-0027
2-13-37, Honmachi, Fuchu, Tokyo, Japan
TEL: +81-(0)42-368-2126
FAX: +81-(0)42-364-0067

◆ Table of contents ◆

1.Outline	3
2.Specification	3
2.1.Operating environment	3
2.2.USB	3
2.3.Product specification	4
2.4.Photo MOS relay	4
2.5.Photo coupler	4
2.6.Appearance	4
3.Install	5
3.1.Windows Vista / 7.....	5
4.Operation.....	6
4.1.Preparation	6
4.2.Function	6
4.2.1. FT_Open	6
4.2.2. FT_OpenEx.....	6
4.2.3. FT_Close	7
4.2.4. FT_SetBitMode	7
4.2.5. FT_SetBaudRate	7
4.2.6. FT_Write.....	8
4.2.7. FT_GetBitMode.....	8
5.Connector table.....	9
6.Warranty.....	9

1.Outline

ZS-6204E has built-in photo MOS relays and photocouplers.

It is possible to perform insulation between circuits, level conversion by operating photo MOS relay or photocoupler.

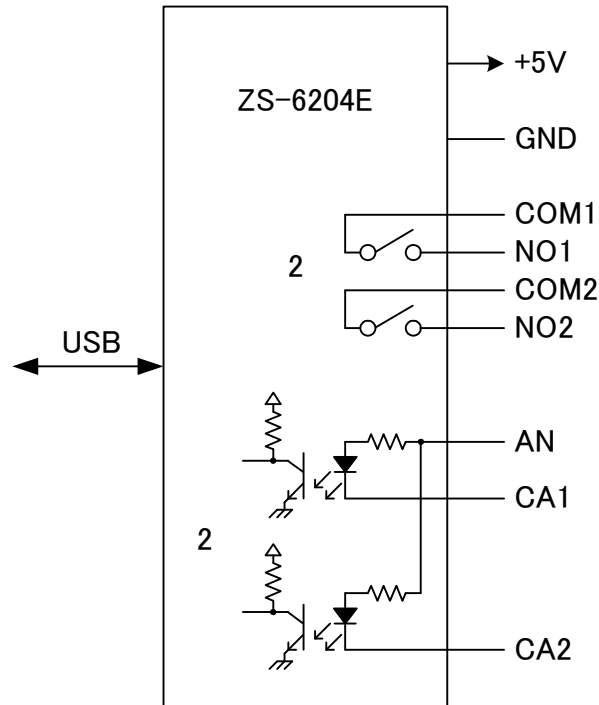

2.Specification

2.1. Operating environment

- PC : IBM PC/AT compatible machine (USB port required)
- OS : Microsoft Windows Vista, 7, 8
: Linux
: Mac

Note) We do not check the operation by Linux and Mac.

2.2. USB

Compliant with USB2.0 standard.

2.3. Product specification

Model	ZS-6204E
Data connector	D-SUB 9-pin connector
Power supply	USB bus power (DC4.75V to 5.25V 100mA or less)
Environment for usage	Temperature 0°C to 50°C Humidity 85% or less
Storage temperature	-20 to 80°C
Size	37(W) × 16(H) × 52(D)
Accessory	Data connector DE-9P-NR

2.4. Photo MOS relay

Relay	TLP3215
Contact resistance	1.5Ω or less
Rated load	40V, 300mA
Operation time	5ms or less
Recovery time	5ms or less

2.5. Photocoupler

Photocoupler	PS2911-1-A/K
Input voltage	DC5V to DC24V

2.6. Appearance



3. Install

3.1.Windows Vista / 7

In order to use this product, it is necessary to install the device driver at first.

When it is connected to a computer that is installed Vista, the following screen will be displayed.

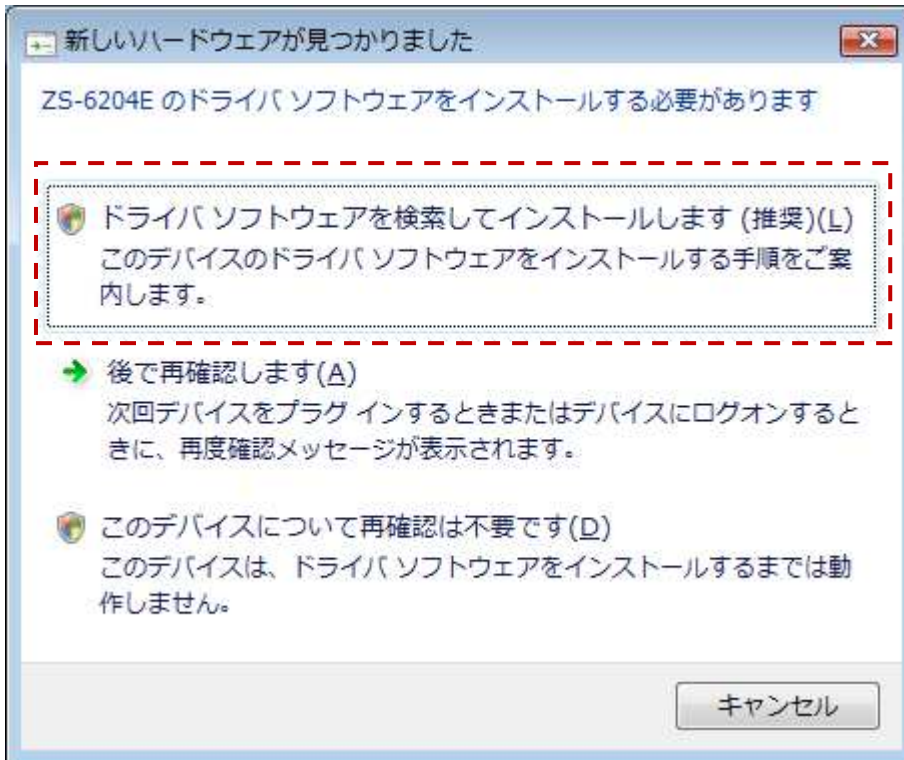

Click “Search and install driver software”, installation will start automatically.

In case of Windows 7 and later, nothing is displayed and installation will start automatically.

If it is not installed automatically please download the driver from our website and install again.

URL <http://www.zenisu.co.jp/>

4. Operation

4.1. Preparation

ZS-6204E uses FTDI's

Visual Basic	:D2XX_Module.bas
Visual C++	:FTD2XX.H, FTD2XX.lib
Delphi	:D2XXUnit.pas

4.2. Function

In order to control the relay and input the photocoupler, use the following function.

FT_Open	: Open the USB port.
FT_OpenEx	: Open the USB port. Please use this if you use more than two.
FT_Close	: Close the USB port.
FT_SetBitMode	: Set the input/output of ZS-6204E.
FT_SetBaudRate	: Set the rewrite time.
FT_Write	: ON/OFF of the photo MOS relays.
FT_GetBitMode	: Load photocoupler.

4.2.1. FT_Open

- Function
Open the USB port and initialize.
- Format
FT_Open (int iDevice, FT_HANDLE *ftHandle)
iDevice : Set to "0".
ftHandle : The handle number will be returned if "FT_Open" is successful.
It will be used this handle number when using other functions.
- Return number
FT_OK : 0 is success
Other than "0" : Error code

4.2.2. FT_OpenEx

- Function
Open the USB port and initialize. When using two or more units, use "FT_OpenEX". You can control more than two by executing "FT_OpenEX" for each one, acquiring each handle number and using it for other functions.
Please also check [D2XXPF34.pdf](#) in the manual folder on the attached CD.
- Format
FT_OpenEx (PVOID pvArg1, DWORD dwFlags, FT_HANDLE *ftHandle)
pvArg1 : Set the product serial number(K-xxxxxx).
dwFlags : Set FT_OPEN_BY_SERIAL_NUMBER
ftHandle : The handle number will be returned if "FT_Open" is successful.
It will be used this handle number when using other functions.
- Return number
FT_OK : 0 is success
Other than "0" : Error code

4.2.3. FT_Close

- Function
Close the USB port and execute driver termination processing.
- Format
FT_Close (FT_HANDLE ftHandle)
ftHandle :Set the handle number
- Return number
FT_OK :0 is success
Other than “0” :Error code

4.2.4. FT_SetBitMode

- Function
Set the 8-bits input/output
- Format
FT_SetBitMode (FT_HANDLE ftHandle, UCHAR ucMask, UCHAR ucMode)
ftHandle :Set the handle number
ucMask :Set HEX(FC) 0:input, 1:output

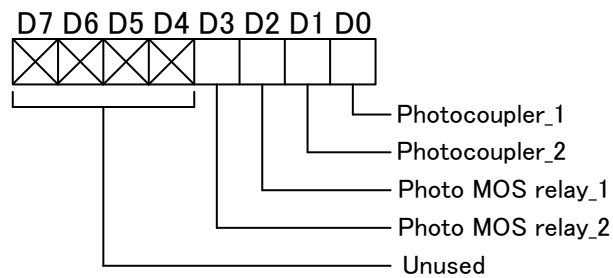

- ucMode :Set “1”
- Return number
FT_OK :0 is success
Other than “0” :Error code

4.2.5. FT_SetBaudRate

- Function
Set the rewrite time of output data.
- Format
FT_SetBaudRate (FT_HANDLE ftHandle, DWORD dwBaudRate)
ftHandle :Set the handle number
DwBaudRate :Set to 9600
When set to 9600, data is rewritten at $1 / (9600 \times 16) = 6.51 \mu\text{s}$ cycle. If there is no data in the buffer, the previous output is continued.
- Return number
FT_OK :0 is success
Other than “0” :Error code

4.2.6. FT_Write

➤ Function

Set ON/OFF of relay.

➤ Format

FT_Write (FT_HANDLE ftHandle, LPVOID lpBuffer, DWORD dwBytesToWrite, LPDWORD lpdwBytesWritten)

ftHandle :Set the handle number

lpBuffer :Set to "1" is ON, "2" is OFF and Byte-output is execute.

Bit assignments are as follows.

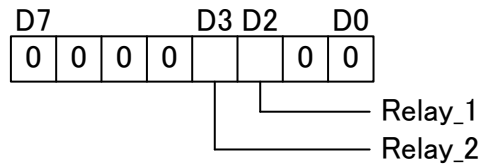

dwBytesToWrite :Set "1"

lpdwBytesWritten :Set "1"

➤ Return number

FT_OK :0 is success

Other than "0" :Error code

4.2.7. FT_GetBitMode

➤ Function

Load photocoupler

➤ Format

FT_Read (FT_HANDLE ftHandle, PUCCHAR pucMode)

ftHandle :Set the handle number

pucMode :When the photocoupler is driving, it is "0".

When the photocoupler is not driving, it is "1".

Bit assignments are as follow.

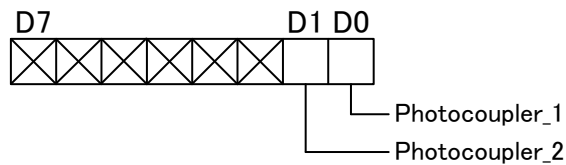

➤ Return number

FT_OK :0 is success

Other than "0" :Error code

5. Connector table

Connector: DE-9S-NR

Signal	Pin No.	Signal
GND	1	
		6
COM1	2	COM2
		7
NO1	3	NO2
		8
CA1	4	CA2
		9
+5V	5	

Relay

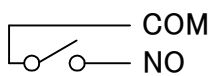

Photocoupler

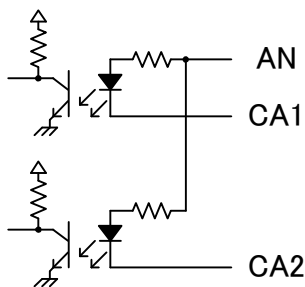

6. Warranty

If it fails during normal use, we will repair it free of charge as described in this warranty as below.

- 1) During the warranty period which is one year from the date of purchase, we will repair it free of charge in case of malfunction in accordance with instruction manual.
- 2) It will be charged for extra in the following case, even during warranty period.
 - Incorrect usage or failure or damage caused by carelessness.
 - Failure or damage caused by improper repair or remodeling.
 - Failure or damage caused by external factors such as fire, earthquake, other natural disasters, abnormal voltage and so on.
 - Replacement of consumable parts.
 - Change of power supply and voltage.
- 3) This warranty provision is effective only in Japan.